

# APEX® DECK INSTALLATION GUIDE



# Apex®

[www.eva-last.com](http://www.eva-last.com)

0322 V2

A PRODUCT BY

**EVA-LAST®**  
INSPIRED BY NATURE, DESIGNED FOR LIFE.

### CONTENTS

1. Family of profiles and secondary components	Page 3 - 5
• Deck boards	
• Fasteners	
2. Pre-installation	Page 6
• Standards	
• Safety	
• Storage and handling	
• Planning	
• Site preparation	
3. Cutting and fastening	Page 7 - 9
• Cross Cutting	
• Ripping and top fixing	
• Profile limitations	
• Installation of grooved deck board	
4. Joist spans	Page 10 - 12
5. General	Page 13 - 19
• Expansion and contraction	
• Slip resistance	
• Important measurements	
6. Disclaimers and Copyright	Page 20

### Introduction



Thank you for choosing Eva-Last® decking. In these guidelines we aim to assist you in successfully completing an installation that will last as long as the Eva-Last® decking products themselves.

- The purpose of this guide is to help you adhere to all Eva-Last® warranty specifications and create a durable, long-lasting installation.
- Please note the limitations of this guide:
  - o This guided intended only for Eva-Last® single level square decks.
  - o The person using these guidelines should already have a basic understanding of deck building practices.
  - o Decks must be built in accordance with federal and local bi-laws and building codes.

Please bear in mind that decks of varying shapes may require different calculations and techniques. Please do not hesitate to contact Eva-Last® should you need any technical assistance at any stage of your build.





The Apex® range was developed to provide a lightweight alternative to the Eva-Last® cellulose-polymer range. The foamed mineral-polymer core has improved water absorption. The innovative double layer polymer coat provides a unique texture and aesthetic characteristic as well as improved slip resistance.

### 1. Family of profiles

Description	Profile width (mm)	Depth (mm)	Typical length (mm)	Coverage (m/m²)*	Mass per meter (kg/m)
 Grooved deck board	140	24	5 700	5.10	3.18
			5 450		
			4 800		
Available in a sigle sided and double sided boards.	190	24	5 700	5.10	3.18
			5 450		
			4 800		
 Grooved deck board Single sided	135	24	5 700	5.10	3.18
			5 450		
			4 800		
 Square edge deck board	140	24	5 700	5.10	3.18
			5 450		
			4 800		
Available in a sigle sided and double sided boards.	190	24	5 700	5.10	3.18
			5 450		
			4 800		

\*Coverage includes a 5mm gap between boards.





### Fascia and batten profile specifications

Description	Profile width (mm)	Profile height (mm)	Typical length (mm)	Coverage (m/m <sup>2</sup> )*	Mass per meter (kg/m)
 Single sided fascia board	150	12	2 200	6.5	1.3
 Single sided fascia board	254	13	2 200	3.9	2.3
 Single sided fascia board	297	16	2 200	3.4	3.0
 Single sided fascia board	184	14	2 200	5.5	2.1
 Batten	40	30	2 800	N/A	1.1

\*Coverage includes a 5 mm gap between boards.  
\*\*Spans are based on boards in a vertical orientation.

### 2. Secondary components - fasteners



#### Typical deck fastener used in timber frame application

Fastener type	Standard size	Length (mm)	Material	Pull out resistance (N)*	Recommended torque (N/mm)	Note
 Hidden fastener: Clip	N/A		SS 430	N/A	N/A	Two sizes available for use with boards that have 6 mm (S6) or 9 mm (S9) groove heights.
 Hidden clip fastener: Screw	M4.2	40	C 1022	4 400 to 6 250	4 100	Designed for both S6 and S9 Hulk hidden deck fasteners.
			SS 305	3 900 to 4 500	N/A	
 Top fixing deck screw	M5.0	63	C 1022	7 150 to 9 900	7 550	Designed for boards of 20 to 25 mm thicknesses into timber structures greater than 40 mm thick.
			SS 305	5 550 to 6 900	N/A	
 Top fixing trim screw	M5.5	48	10B21	4 550 to 7 150	7 450	Designed for boards of 11 to 16 mm thicknesses into timber structures greater than 40 mm thick.
			SS 316	5 000 to 6 500	N/A	

Appropriate fasteners must be employed depending on the expected worst-case loading conditions, the intended application and the conditions present. Particular attention should be paid to the substrate conditions available and the environmental conditions of the site. All applications should adhere to applicable regional standards. All timber profiles should be treated appropriately. Regular and proactive maintenance should be employed.

\*Pull out resistance range is based on testing with fasteners in ACQ timber (density of 0,67 g/cm<sup>3</sup>) to Red oak timber (density of 0,72 g/cm<sup>3</sup>).

### Typical deck fastener used in metal frame application

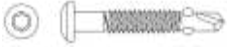
Fastener type	Standard size	Length (mm)	Material	Pull out resistance (N)*	Recommended torque (N/mm)	Note
 Hidden fastener(Clip)	N/A		SS 430	N/A	N/A	Two sizes available for use in a 6 mm (S6) and 9 mm (S9) groove height.
 Hidden clip fastener	M4.2	40	C 1022 SS 410 H	3 850 4 030	5 300 6 670	Designed for both S6 and S9 Hulk hidden deck fasteners.
 Top fixing deck screw	M4.8	45	C 1022	3 470	9 610	Designed for boards of 20 to 25 mm thicknesses into metal structures 0.8 to 2.0 mm thick.
 Top fixing trim screw	M5.5	35	10B21 SS 410 H	5 717 6 138	10 890 14 220	Designed for boards of 11 to 18 mm thicknesses into metal structures 0.8 to 2.0 mm thick.

Appropriate fasteners must be employed depending on the expected worst-case loading conditions, the intended application and the conditions present. Particular attention should be paid to the substrate conditions available and the environmental conditions of the site. All applications should adhere to applicable regional standards. All metals should be appropriately coated. Regular and proactive maintenance should be employed.

\*Pull out resistance is based on testing with fasteners into 2.0 mm steel plate with a hardness of HV146.

## 2. Pre-installation

### Standards

Legislation may differ between jurisdictions. Before installing any Eva-Last<sup>®</sup> product, ensure that the application is rational and complies with the local regulations and building codes. Wherever necessary, consult a suitably qualified professional. Be sure to comply with material manufacturer specifications. Where manufacturers and building codes differ, revert to the building code requirements. Check that your choice of product is suitable for its intended application. For further product specification and information visit [www.eva-last.com](http://www.eva-last.com)

### Safety

- Always wear appropriate personal protection equipment (PPE). Comply with the local occupational health and safety legislation.
- Refer to the applicable Material Safety Data Sheet (MSDS).
- Cutting Apex<sup>®</sup> produces fine particulate matter.
  - Work in well-ventilated areas.
  - Wear dust masks during cutting, drilling and cleaning.
  - Clean up saw-dust by vacuuming or wetting the area down and sweeping.
  - Always wear safety goggles whilst cutting and/or installation.
  - Cut boards may have sharp edges (particularly mitered cuts).
  - Wear gloves when working with boards.

### Storage and handling

- Individual boards are lighter than WPC and can be more easily handled. Boards are, however, bundled for convenience and can, as a result, be heavy. Take care when lifting, placing or removing from raised pallets. More than one person may be required for lifting depending on the length of the boards and the number of boards within a bundle. Ensure the mass handled does not exceed safe limits as defined by applicable local legislation.
- When handling lengths of boards greater than 4m, ensure both ends are lifted simultaneously and evenly. Lift the boards 1 m from each end to provide better control.
- Handle the boards carefully. Dropping the boards (and all high impact loads in general) can result in damage to the profiles.
- During transportation use corner protectors where strapping is required.
- All components should be stored completely under cover.
- When storing boards, a pallet or flat surface should be used to support the full length of each component.
- All components should be securely stored.
- No component should sit in water or similar.
- Avoid over-stacking and/or eccentric stacking.

### Plan

- Assess the site environment and ensure the product is suitable for the intended application.
- Classify the corrosion category, loading class, and any other property that will influence the selection of product.
- Determine appropriate spans for the selected profile. This will depend on the application and the loading class for the region.
- Suggested spans are provided for typical residential scenarios (refer to Installation guide).
- An appropriately qualified professional must be consulted whenever necessary to ensure the product, this document and the intended application complies with all applicable legislation for that region.
- Develop a maintenance plan to ensure the longevity of the system. This should consider drainage, corrosion and vegetation under and around the deck.

### Site preparation

- Ensure adequate drainage below the deck footprint. Prevent pooling water and/or erosion.
- Remove vegetation from the deck footprint and place an appropriate geotextile to prevent regrowth.

### 3. Cutting and Fastening

#### Cross cutting

- Use a fine toothed, carbide tipped blade to cut Apex® material.
- Use an 80-tooth, 260 mm diameter cross-cut, or finer, blade.
- Do not rip boards thinner than 60 mm. Use a minimum of two fasteners per joist, evenly spaced and a minimum of 30 mm from any board edge.
- Apex® boards are provided as factory cut. Ends should be trimmed to carpentry cut.
- Boards can be mitered. Use two fasteners, evenly spaced and a minimum of 30 mm from any edge, per mitered board.
- Do not router Apex® boards.

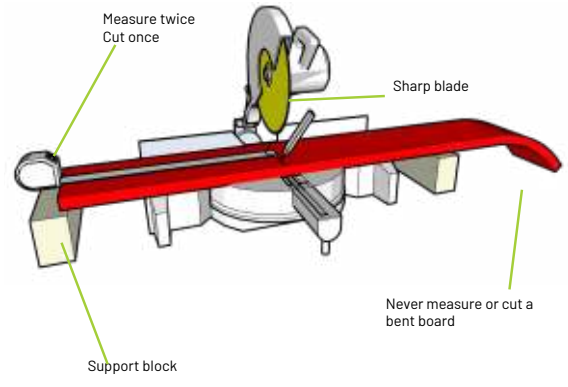

#### Ripping and top fixing

For best results ripping composite boards, or cutting the boards lengthwise, use a ripping jig if a table saw is not available. Before ripping a board, consider the following:

#### Adjusting for cutting boards outside of limitations

It may be necessary to rip the last deck board to fit the size of the installation area. In this case, avoid cutting any board too thin, or to less than 65 mm. It is better to rip both the first and last boards to fit your installation space than to rip either board too thin.

When fastening a ripped board, use either a screw and a hidden fastener, or two screws to support the ripped board, dependant on how thin they may be.

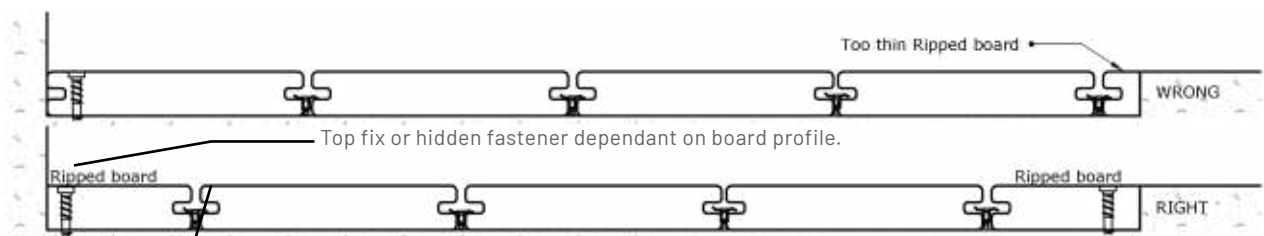

#### Profile limitations based on top fixing

While solid composite profiles or boards can be ripped, minimum edge distances must be taken into account before boards are ripped. A minimum edge distance of 30 mm prevents board cracking. A minimum distance of 30 mm between screws prevents cracks forming between fasteners. As a result profile limitations are based around fastener edge distances, rather than board limitations.

For example:

At 30 mm from the any edge of a deck board or fastener. A board can only be ripped to 90 mm. However where a hidden fastener is used, the board is supported along the edge of the deck board, and a single top fixing screw can be used, reducing that to 60 mm. In cases where spans can be reduced and no groove is available, screws can be staggered reducing the distances between fasteners to 15 mm if staggered.

#### Suitable profile ripping and fastening options

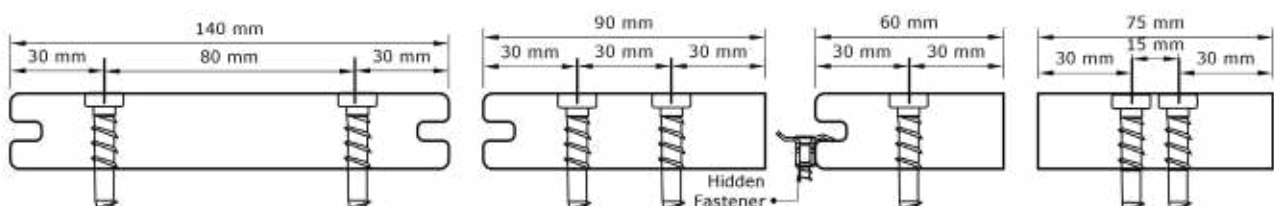

### Fastening limitations when top fixing

- When top fixing deck boards, fasten the boards 30 mm or farther from any edge of the board, and at a spacing of 30 mm to the next fastener to avoid any board cracking.
- Use at least two screws to fasten each board to avoid the board pivoting around one screw and cracking.
- In order to allow sufficient room for proper fixing (and necessary distances between fasteners), the width at which a deck board can be cut is limited. Consider the following before cutting or ripping boards:
  - \* A full-width board of 90 mm and above has plenty of space for all fastening requirements.
  - \* Boards can be reduced to a width of 60 mm if a hidden fastener is used along with one screw.
  - \* Boards can be reduced to a width of 75 mm if two screws are used for fastening, and if the screws are fastened 15 mm from one another with twice the number of screws used along the remaining length of the board.

### Potential fastening options for boards of different widths

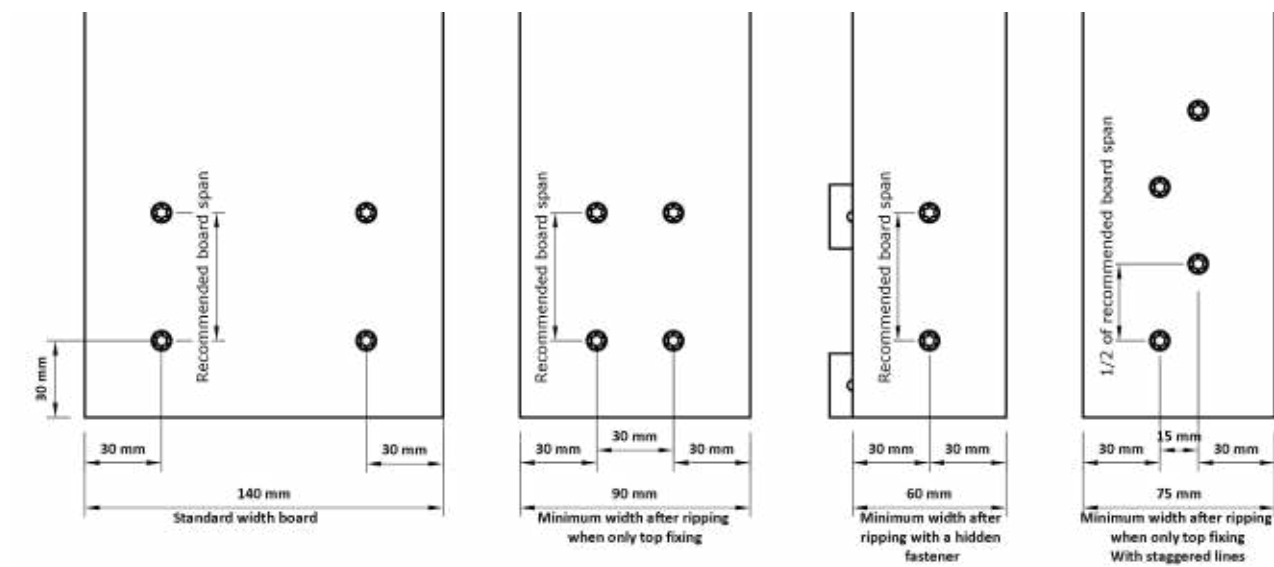

### Triangular piece fastening

Small triangular pieces are often found in diagonal decking as well as where boards have been mitred.

- 1 - It is good practice to fasten all 3 edges of a triangular piece to avoid pivoting.
- 2 - Where small pieces do not allow for this, 2 screws can be used, but should be positioned in such a way as to prevent pivoting. Never use a single screw and always pre-drill holes in small pieces to avoid cracking. Try to plan the deck in such a way that both ends of the deck do not have overly small pieces of decking. Grooved deck boards should have 2 top fixing points where possible, using hidden fasteners or top fixing.
- 3 - Where deck boards are cut at odd shapes like arrow heads additional fasteners may be required to prevent levering.

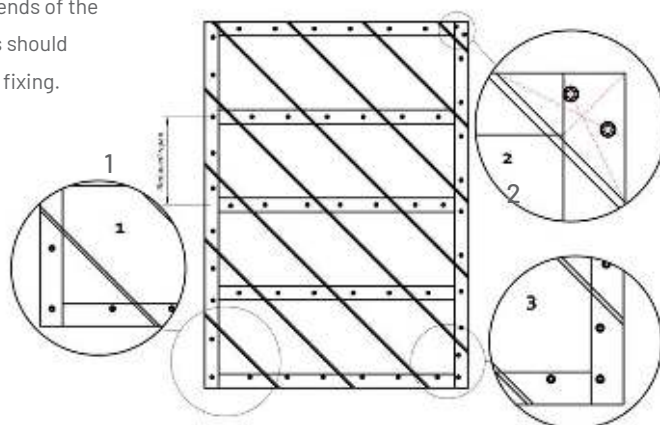



### Fastening

- Do not use nails to fasten Apex® boards.
- Use high quality fasteners suitable for the life span of the deck and the atmospheric conditions of the site.
- Stainless steel 316 fasteners should be used in environments classified as C5 or higher.
- A drill or screwdriver with adjustable torque settings is recommended.
- See required torque settings in the typical fasteners section.
- Do not exceed the recommended torque settings.
- Apex® boards require two fasteners points per joist.
- Fasten 30 mm from any edge of a board.
- Pre-drill composite in temperatures below 5 C°.
- Pre-drilling hole size should be equal to the minor/root diameter of the screw.
- Do not pre-drill timber substructure.
- Pre-drilling metal substructure may influence the effectiveness of the screw wings.
- Pre-drilling can reduce the risk of cap subsidence around the periphery of the screw head (caused when voids within the board core collapse as a result of too much downward force when fastening).

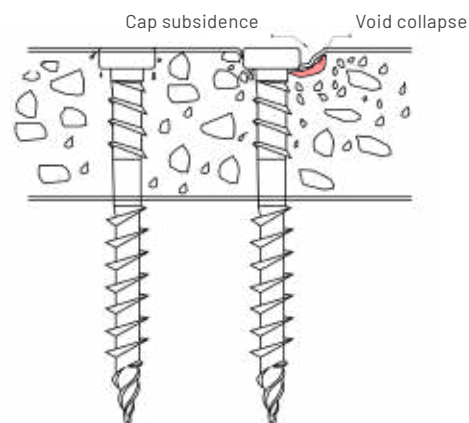

### Process - Installing grooved deck boards

When installing grooved deck boards, be sure to fasten, or top fix, the first board firmly to the structure before using hidden fasteners.

### Deck installation

Installation using a grooved deck board: When you install your first board, it is necessary to fasten the first board firmly to the structure, before using hidden fasteners.

#### Step 1



1. Top fix your first board using a composite deck screw.

#### Step 2



2. Insert a hidden fastener into the groove of the deck board and fasten it into the appropriate structure.

#### Step 3



3. Insert the next board, at an angle. Engaging it with the previous hidden fastener and pressing down.

#### Step 4

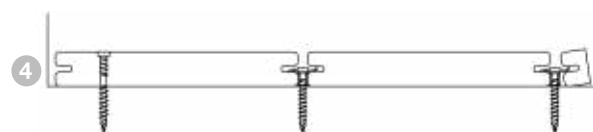

4. Insert and fix the next line of hidden fasteners. Clip the subsequent board into the hidden fastener. Repeat this step until the second-to-last board.

#### Step 5

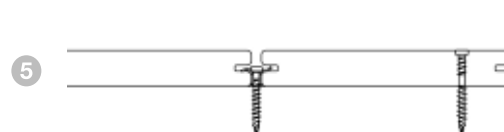

5. Top fix the last board with a composite deck screw.

### 4. Joist spans

Maximum joist spans of 300mm centre to centre, for commercial installations. Joist spans of 350mm on centre can be done for residential applications. For joist spans on angles, please refer to the below table.

#### Flexural strength

See technical data sheets for the flexural properties of specific deck boards and technologies. Recommended joist spans are provided within the family of profiles section based on residential used but must be checked against local building codes to ensure compliance.

#### Temperature influences (Apex®)

Temperatures and moisture have a direct impact on the performance of all deck boards. In areas where extremes of either heat or cold temperatures are experienced during installation, spans may need to be adjusted for normal conditions.

#### Adjusting spans for angles

Where boards are installed at more extreme angles to a joist, the center to center distance increases, reducing the support that the board would receive. As a result, it is necessary to decrease the joist span in proportion to angular change, to maintain the recommended joist spans. Below is a table that speaks adapting the joist spans to the angle of the board and examples of where this may be applicable. 90° has been the standard span, 60 degrees being the most extreme angle from the joist.

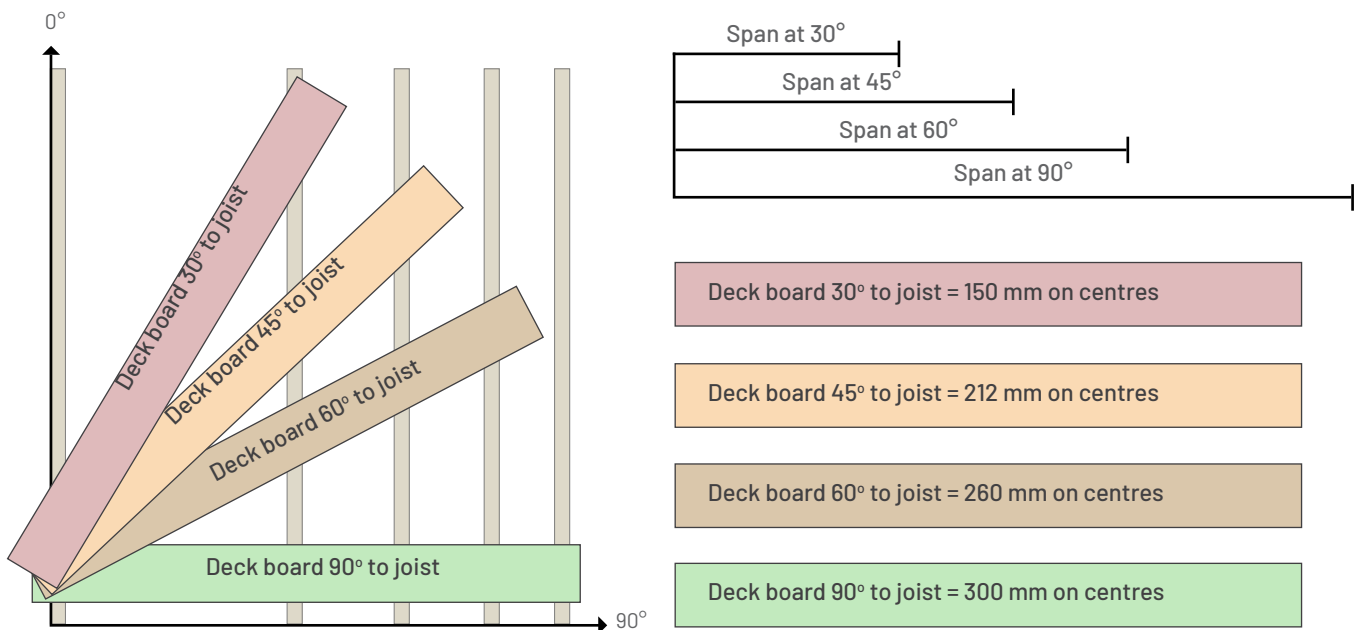

#### Joist spacing to consider when deck boards at different angles to joists:

Common spans at 90° to a support joist (normal)	Common laying pattern angles		
	60°	45°	30°
300 mm	260 mm	212 mm	150 mm
350 mm	303 mm	247 mm	175 mm

### Butt Joints

As has been discussed at length in the expansion and contraction section, allow for expansion between board ends. These board ends require additional support and fastening.

Where unable to use breaker boards, and longitudinal boards butt up against one another, double joists must be used to support the butt joint. Use a minimum of two fasteners per joist, evenly spaced and a minimum of 30 mm from any board edge. Top fix longitudinal boards in this scenario at every joist. Leave a drainage gap between the double joists.

Staggering butt joints so that they do not all align on the same joist, limits the unsightly repetition of expansion gaps. Where the required length of a deck, exceeds the length of a board in odd-shaped laying patterns, double joists do not need to be installed along the entire length of a deck but can be installed between a joist span to save on material.

Mitred boards require double joists. (see the next section for details).

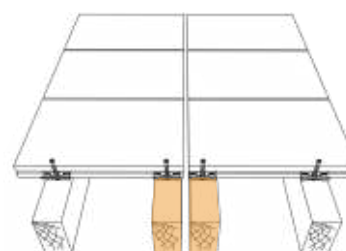

### Examples of laying patterns with butt joints

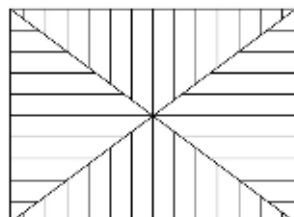
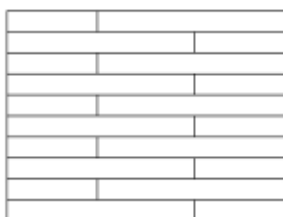

### Theoretical double joist support for butt joints

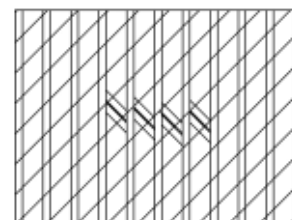
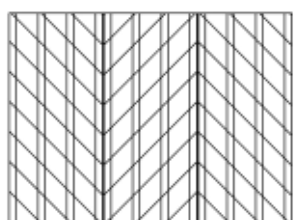
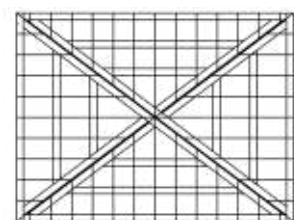
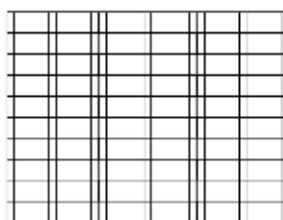

### Breaker boards

Use a breaker board between longitudinal boards to assist in controlling expansion and contraction. This approach has the added benefit of creating a neat aesthetic. Breaker boards must be supported by ladder joists or noggins.

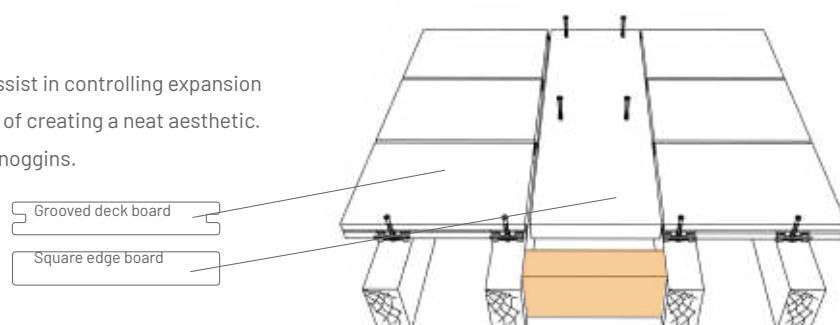

Should you be laying full length deck boards end to end, it is imperative to have a breaker board to control expansion from both ends. As illustrated in this laying pattern.

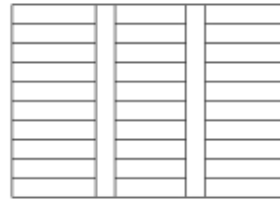

### Examples of other laying patterns with breaker boards

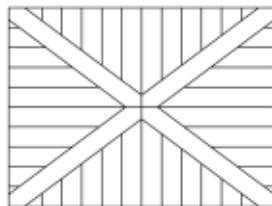
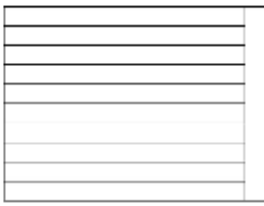

### Theoretical joist support for Breaker joints

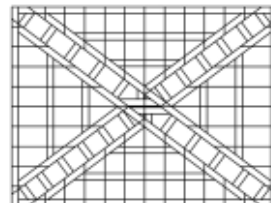
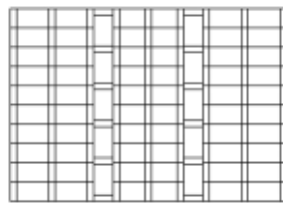
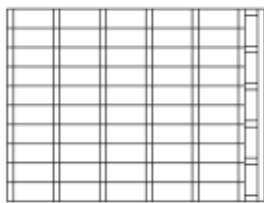

### Rim boards and picture frames

Using deck boards to frame a structure is an aesthetic practice, that may require one or more boards to create a picture frame around the deck. Picture frames boards employ several of the techniques previously discussed, including breaker boards, mitre cuts, and double joists. Picture frames often require mitre cuts on the board edges.

If the deck is longer than a board's supplied length, Divide the length of the deck between two boards for the best aesthetic as is illustrated below. Use double joists at all points where boards join, including mitred points.

Single sided deck boards and square edged boards simplify the installation process and create a neat finish around deck edges.

### Examples of laying patterns with picture frame laying patterns

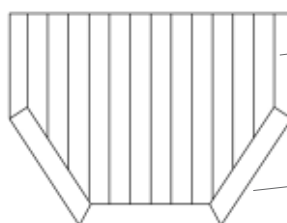
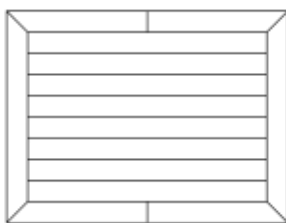

Single sided board

Square edge board

### Theoretical joist support for Breaker boards

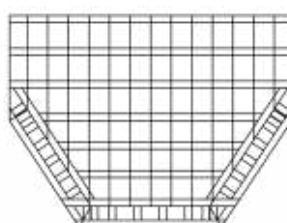
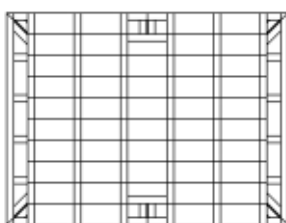

### 5. General

#### Expansion and contraction

The expansion coefficient of the Eva-Last<sup>®</sup> Apex<sup>®</sup> cellulose-polymer composite is approximately  $46 \times 10^{-6} \text{ mm } ^\circ\text{C}^{-1}$ . This means that for every 1 °C change in temperature for a 1 000 mm long profile, the length of the profile will increase or decrease by 0.04 mm. The total change in length will depend on the total change in temperature (of the board) and the length of the profile. The total change in length of a 5 000 mm profile over a temperature change of 30°C will be (on average) approximately 6 mm. The temperature change of the board will also depend on the colour of the board. Darker boards will absorb more energy and, as a result, expand more relative to lighter boards.

The difference between the longest (hottest) and shortest (coldest) positions of the board dictates the required size of the expansion gaps. When leaving an expansion gap between boards, compare the current installation board temperature to what is the expected maximum and minimum board temperatures for that site. Expansion and contraction is uniform and can typically be shared at both ends of the profile. If, however, one end of the board is fixed or abuts an obstruction, the expansion or contraction of the entire board length will be translated to the only free end. Installation can heavily influence the performance of your composite cladding system.

Care must be taken in areas susceptible to large changes in temperature or energy. Typical examples include areas in the path of large reflective surfaces (such as roofs, facades, windows, and doors). Such scenarios will influence the temperature range of boards and the required expansion gaps of the system.

Allowing the boards to acclimatise before installation assists in uniform movement across the system and allows for easier expansion gap design. This also applies to the daily fluctuation of temperature during installation and should try to be incorporated where possible. The use of shorter board lengths can also be utilised to reduce the size of the expansion gap required.

#### Apex<sup>®</sup> Mineral-polymer composite

The foaming process that Apex<sup>®</sup> core material undergoes, creates holes within the composite that make allowances for expansion around fasteners, as the holes in the core material deform to make space for the fasteners.

#### Other materials

All materials expand and contract as a result of the change in temperature of the material. The rate of expansion or contraction depends on the thermal expansion coefficient of each material. Typical rates of most materials are readily available online. When designing and installing a system that consists of several materials, cognizance of the difference in thermal expansion coefficients between the materials and how they interact can be important.

Timber substructures are also susceptible to expansion and shrinkage as a result of moisture. Ensure appropriately treated and/or coated timber is utilised at all times. Ensure that the system is designed and implemented so that the collection or pooling of water does not occur.

Movement of materials can degrade connections with time, and it is prudent that this is avoided or reduced to an acceptable means where possible.

#### Accounting for expansion and contraction during installation

The homogeneous movement of the composite is easily accounted for during installation. The anticipated change in length can be accommodated for using expansion gaps at either end, or at both ends depending on the intended design, by employing the intelligent HULK fasteners™ system. To optimise the size of the expansion gaps, the maximum expected temperature range - in relation to the installed ambient temperature - should be calculated and the corresponding change in length calculated.

### Steps to consider when planning the expansion and contraction gaps

#### 1. Assess the material properties

Composite material properties	Value (mm <sup>-1</sup> °C <sup>-1</sup> )	Expansion and contraction per meter per degree (m <sup>-1</sup> °C <sup>-1</sup> )
The linear thermal expansion coefficient of Eva-tech®	39.3 × 10 <sup>-6</sup>	0.04
The linear thermal expansion coefficient of Infinity® and Origins™	40.1 × 10 <sup>-6</sup>	0.04
The linear thermal expansion coefficient of Apex®	46.2 × 10 <sup>-6</sup>	0.05

#### 2. Assess the climate conditions

Simplified climatic conditions	Climate types		Units
	Coastal	Continental	
Typical seasonal temperature change (conservative and simplified) for different climates	15	30	°C
Seasonal expansion and contraction per meter for different climates	0.75	1.5	m <sup>-1</sup>

#### 3. Estimate maximum total seasonal change in (mm) of board lengths (m)

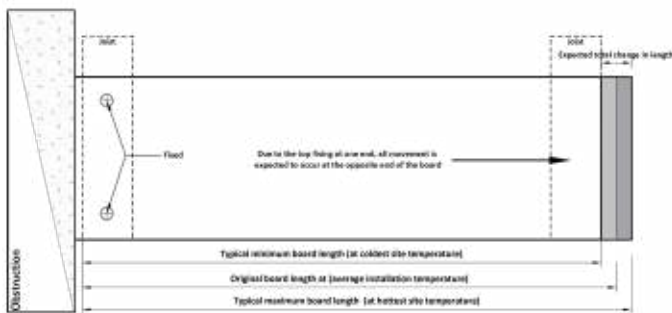

Maximum total seasonal change in length (mm) of board lengths, in a fixed direction

#### Expansion from a fixed point

Various design board length examples	The total resultant change in length		Units
	Coastal	Continental	
5.450 m (full length)	3.3	6.5	mm
2.725 m (half board)	1.6	3.3	mm
1.3625 m (quarter board)	0.8	1.6	mm

#### 4. Distribute the maximum seasonal change in length (mm) over both ends of the boards if possible

Expansion and contraction movement of composite is typically uniform throughout the board. Expansion gaps must attempt to cater for this. Providing expansion gaps at both ends of the boards is good practice. The total expansion gap length (as per the above climate and board lengths) for each side of the board when employing this approach is half the maximum calculated previously. In other words, the expansion gap on each side of the board should be half the total size of the full expansion expected of the entire board.

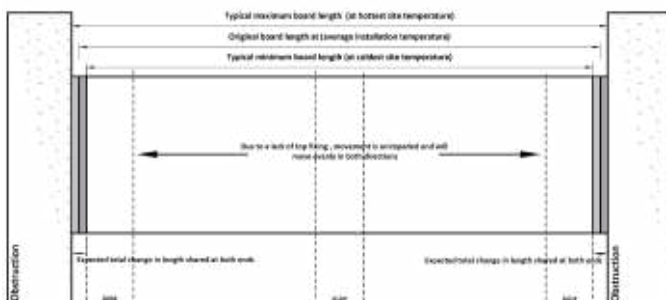

Maximum total seasonal change in length (mm) of board lengths, unimpeded in both directions

#### Distribution of board expansion over two ends

Various design board length examples	The total resultant change in length		Units
	Coastal	Continental	
5.450 m (full length)	3.3	6.5	mm
2.725 m (half board)	1.6	3.3	mm
1.3625 m (quarter board)	0.8	1.6	mm

**Note:** All measurements are provided to the nearest tenth where possible for simplicity. All measurements are based on simplified temperature ranges for typical climates and must be adjusted accordingly for different temperature ranges or different climates. All measurements are based on multiples of the typical board length of 5.45 m and must be adjusted accordingly for boards of different lengths.

### Site temperatures example

In cooler climates, some composite boards expand at approximately 0.75 mm/m of a composite deck board. When leaving an expansion gap for each board, compare the current installation temperature (ambient) to what is common maximum or minimum temperature for that site. If you are installing at 06:00 in the morning the middle of winter, it will be close to the minimum temperature the board will experience. As a result, the board will be the 'shortest' it will ever be at the time of installation. As the temperature rises, the board will expand. When it gets to the peak temperature in the middle of summer, the board will have expanded to the 'longest' it will ever be.

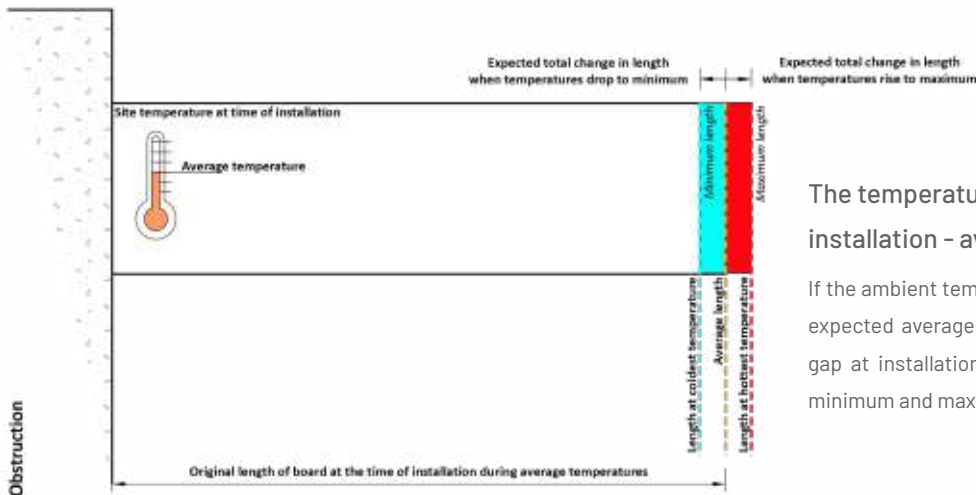

### The temperature at the time of installation - average

If the ambient temperature at the time of installation is the expected average temperature of the site, the expansion gap at installation must be the average of the expected minimum and maximum lengths of the boards.

### The temperature at the time of installation - hotter than average

If the site is hotter than the expected average temperature, the boards will contract when the temperature drops to the average temperature. Therefore, the installed expansion gap must be adjusted shorter.

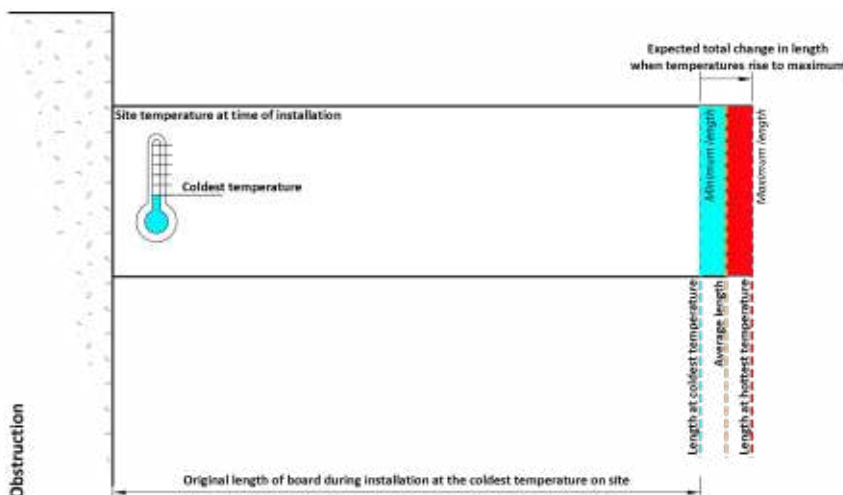
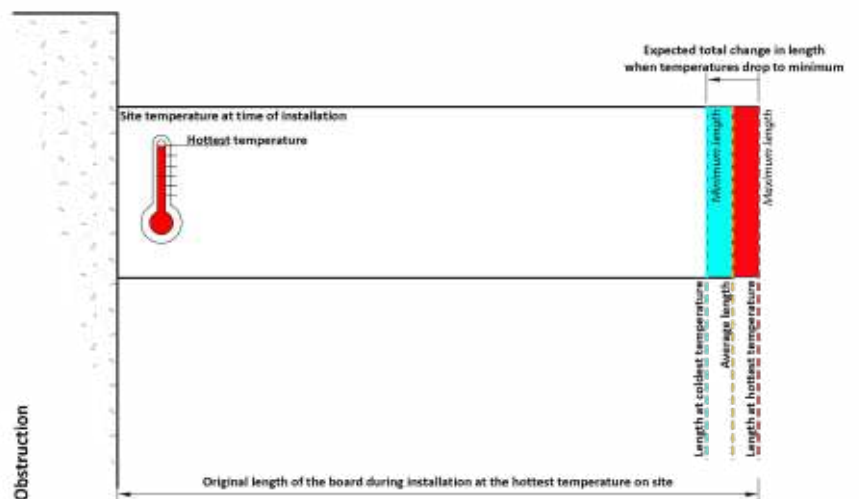

### The temperature at the time of installation - colder than average

If the installation site is colder than the expected average temperature, the boards are expected to expand when the temperature rises to the average temperature. Therefore, the installed expansion gap must be adjusted longer.

### Maximum expansion and contraction points

The difference between the longest and shortest positions of the board dictate the required size of the expansion gap. Remember, the starting position of the expansion gap will depend on the starting temperature or installation temperature. Therefore, boards installed closer to the minimum site temperature will have to have a relatively larger starting gap, since the boards will expand as the temperature rises. Boards installed closer to the maximum site temperature will have to have a relatively smaller starting expansion gap, since the boards will contract or 'shrink' as the temperature decreases.

### Acclimatisation

Installation can take place over a few days, resulting in varying installation temperatures. Depending on the project site, the boards may experience differing heating and cooling rates. Therefore, the boards may expand and contract at varying rates. Once the installation is complete, wait to cut the ends of the installed boards to the desired length in order to allow the boards to acclimatise to the site.

Allow time for boards to acclimatise before cutting ends

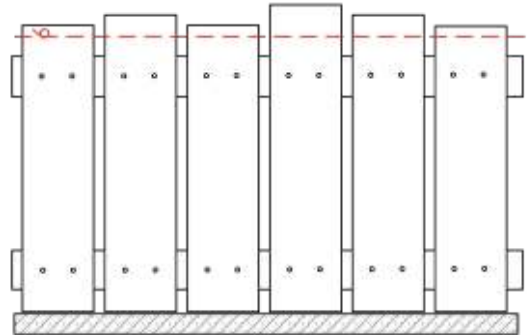

### Expansion and contraction in decking applications

Typical installations will have breaker boards or perimeter boards between each longitudinally-placed board. The expansion gap in these cases should adhere to the calculations above, depending on the climate and original length of the board.

### Expansion in uniform rows of boards

Breaker boards aid by providing a single straight line against which the ends of boards can expand and contract to give the illusion of a straight line, resulting in better aesthetics. Noggins are used to support the breaker board. The breaker board needs to be top fixed to these noggins.

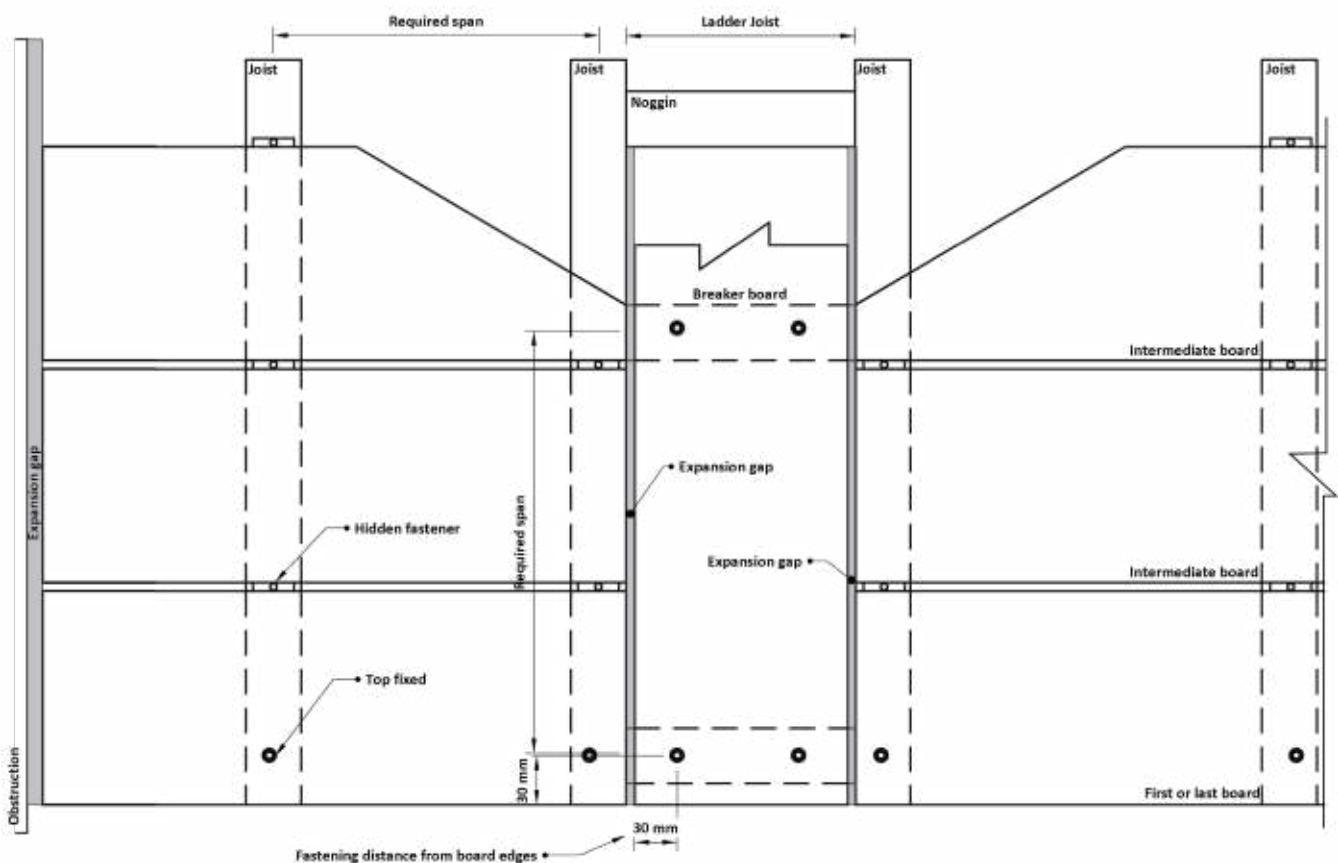



### Expansion by multiple rows of boards placed consecutively

Where breaker boards can not be used, expansion gaps provide for the change in length of both boards. Stagger the boards to hide any uneven expansion as a result of temperature differences in the boards during installation throughout the day.

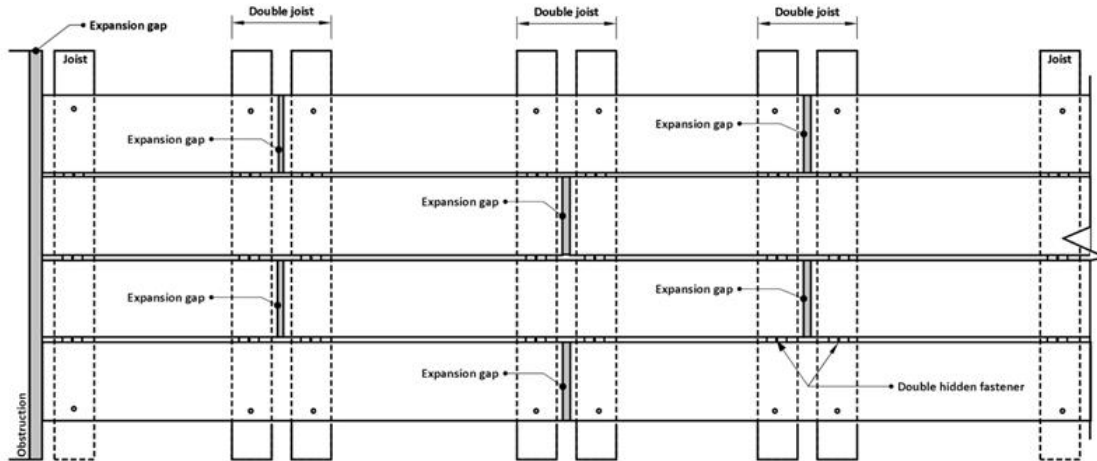

**Staggered laying pattern**

### Providing for code compliance in expansion gaps

When installing against vertical structures, allow for both the code-required spacing and the material required expansion gap to ensure transgression of the code does not occur as a result of board movement.

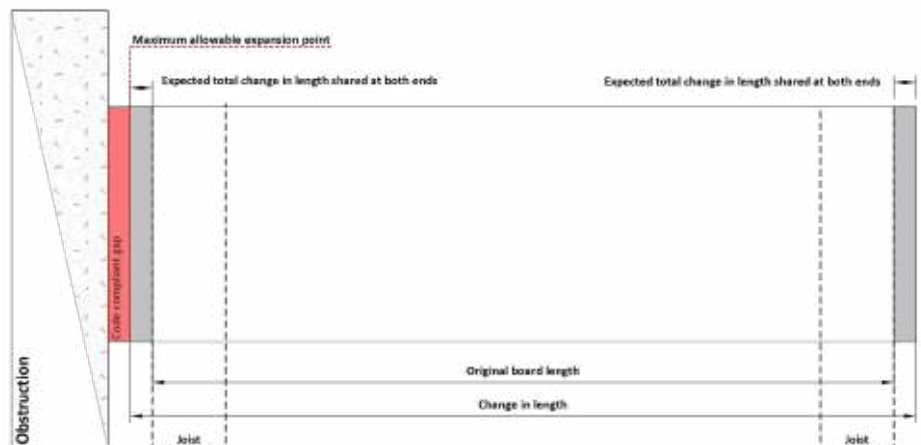

### Slip resistance properties (Typical example)

When installing flooring in external applications, slip resistance should be considered. In areas where slipping is a concern, such as entrances, boards can be positioned in a way as to take advantage of their slip resistant characteristics. Regional standards can be very specific about the required slip resistance of external flooring and should be checked.

#### Finish: L

Physical properties	Measured value	Test standard	Note
Slip resistance	65	AS 4586 2013 Appendix A - Wet pendulum	With grain Class P5
Slip resistance	67	AS 4586 2013 Appendix A - Wet pendulum	Across grain Class P5
Slip resistance	0.95	AS 4586 2013 Appendix B - Dry floor friction	Class D1
Slip resistance (°)	34.0	AS 4586-2013 Appendix A - Wet-barefoot inclining platform	Class C
Slip resistance (°)	26.4	AS 4586-2013 Appendix A - Oil-wet inclining platform	Class R11

### Installation points

#### Board application

- The installation of Apex<sup>®</sup> boards is comparable to that of other composite or timber decking materials.
  - Refer to Apex<sup>®</sup> decking installation guide for details.
- Apex<sup>®</sup> profiles are not intended for use as structural members.
- Provide ground clearance for adequate ventilation. Improved ventilation can have the added benefit of assisting with expansion and contraction.
- The overhang of boards must be limited to 30 mm.
- Leave expansion gaps between boards. The linear expansion coefficient of Apex<sup>®</sup> is  $46.2 \times 10^{-6} \text{ }^{\circ}\text{C}^{-1}$ . For further details on expansion and contraction, refer to the full installation guide.
- Reflective surfaces (for example, low-E glass or metallic roofing) may cause unusual UV impact and/or heat build-up on a deck which may cause unexpected results in the Apex<sup>®</sup> material. Design your deck to cater for this where possible.
  - Use a breaker board between longitudinal boards to assist in controlling expansion and contraction. This approach has the added benefit of creating a neat aesthetic. See Installation guide for further details.
  - Breaker boards must be supported by ladder joists or noggins.
  - Where breaker boards cannot be used, and longitudinal boards butt up against one another, double joists must be used to support the butt joint. Use a minimum of two fasteners per joist, evenly spaced and a minimum of 30 mm from any board edge. Ensure longitudinal boards in this scenario are top fixed at every joist.
    - Stagger butt joints so that they do not all align on the same joist. This limits unsightly repetition of expansion gaps.
- Joist spans should be altered in cases where boards are installed diagonally (for example, with Herringbone patterns). See Installation guide for details.

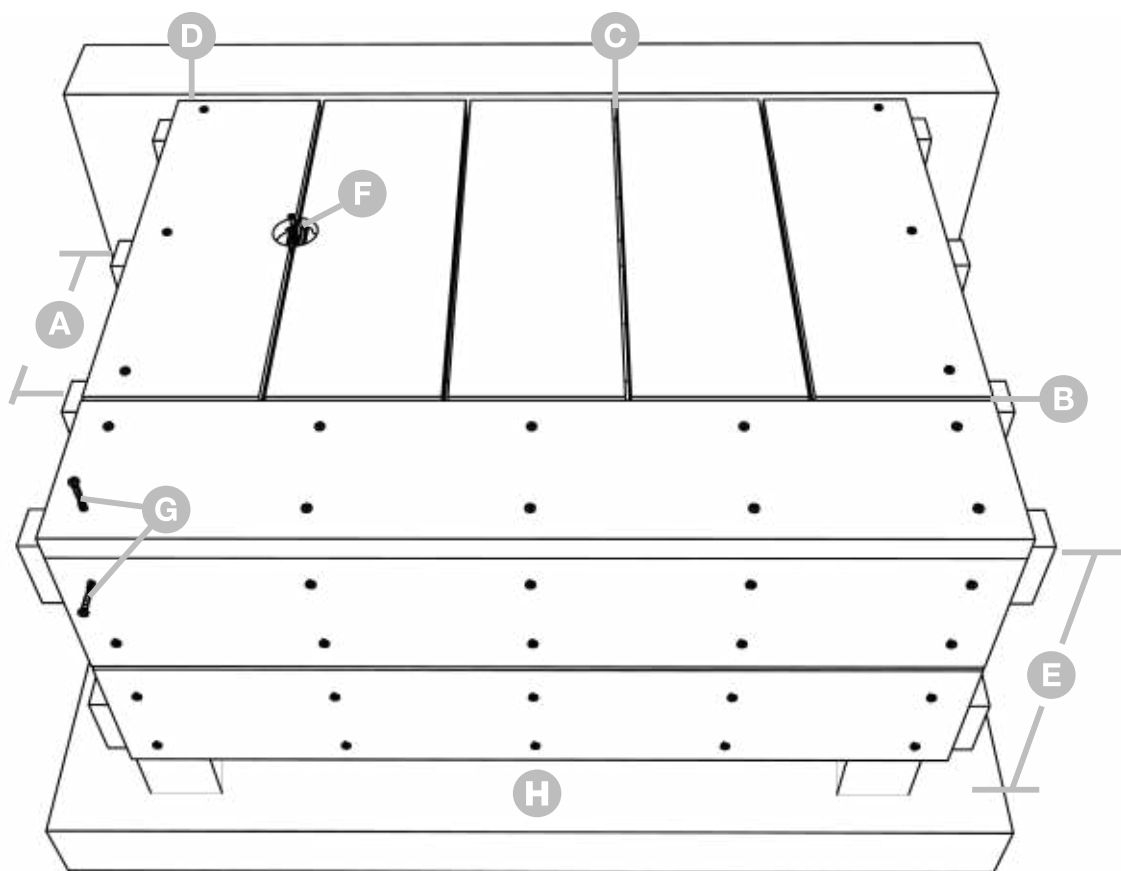

### Specifications

Description	Grooved board	Square edge board
<b>A</b> Joist spacing	Profile dependant	Profile dependant
<b>B</b> Expansion gap	46.2 x 10 <sup>-6</sup>	46.2 x 10 <sup>-6</sup>
<b>C</b> Gap between boards	6 mm	6 mm
<b>D</b> *Ventilation gap between deck and wall	12 mm minimum	12 mm minimum
<b>E</b> *Minimum deck height	300 mm	300 mm
*Ground clearance over concrete	40 mm	40 mm
<b>F</b> Fastener type	Hidden fastener	Top fixing
<b>G</b> Screw type	Clip screw	Deck screw
<b>H</b> *Ventilation gap beneath fascia boards	40 mm	
Maximum board overhang	25 mm	25 mm
Fastening distance from board edge	30 mm	30 mm

\*Dependant on regional standards.

## 6. Disclaimers and Copyright

### Document disclaimer

The provided information is offered in good faith as accurate, but without guarantee, Eva-Last® makes no warranties or representations of any kind (express or implied) about the accuracy, adequacy, currency or completeness of the information, or that it is suitable for the intended use.

Compliance with this material safety data sheet does not guarantee immunity from breach of any statutory requirements, building codes or relevant standards. The final responsibility for the correct design and specification rests with the designer and, for its satisfactory execution, with the contractor. Appropriate warnings and safe handling procedures should be provided to handlers and users.

While most data has been compiled from research, case histories, experience and testing, small changes in environment can produce marked differences in performance. The decision to use a material, and in what manner, is made at your own risk. The use of a material and method may therefore need to be modified to its intended end use and environment.

Eva-Last®, its directors, officers or employees shall not be responsible for any direct, indirect or special loss or damage arising from, or as a consequence of, use of, or reliance upon, any information contained in this document or other documents referenced herein. Eva-Last® expressly disclaims any liability which is based on, or arises out of, the information or any errors, omissions or misstatements herein.

### Utilisation disclaimer

Legislation may differ between jurisdictions. Before installing any Eva-Last® product, ensure that the application is rational and complies with the local regulations and building codes. Wherever necessary, consult a suitably qualified professional. Be sure to comply with material manufacturer specifications. Where manufacturers and building codes differ, revert to the building code requirements. Check that your choice of product is suitable for its intended application. For further product specification and information visit [www.eva-last.com](http://www.eva-last.com)

### Copyright

If reprinted or reproduced or utilised in any form Eva-Last® should be acknowledged as the source of the information.

Eva-Last® periodically updates the information contained in this document and that of the Eva-Last® documents that have been referenced herein. Before using this document, please refer to the Eva-Last® website ([www.eva-last.com](http://www.eva-last.com)) for the most up to date documents. Please refer to the applicable websites for the most recent updates on information contained herein pertaining to other sources.

### Contact information

**Physical address:** Eva-Last® Distributors,  
Room 1203, 12/F Tower 3,  
33 Canton road,  
Tsimshatsui Hongkong, China.

**Emergency contacts:** +27 10 593 9220

**Product information:** +27 10 593 9220

**Email:** [sales@eva-last.com](mailto:sales@eva-last.com)

**Website:** [www.eva-last.com](http://www.eva-last.com)